

# Nilsson Model

- Spherical Shell Model
- Deformed Shell Model
  - Anisotropic Harmonic Oscillator
  - Nilsson Model
    - Nilsson Hamiltonian
    - Choice of Basis
    - Matrix Elements and Diagonalization
    - Examples. Nilsson diagrams

# Spherical shell model

Nuclear properties described in terms of nucleons considered as independent particles moving in an average potential created by all nucleons.

Experimental evidence for shell effects:

Existence of magic numbers: 2,8,20,28,50,82,126

- Large single particle separation energies
- Nuclei are strongly bound at shell closures

Derivation of the average field from microscopic two-body forces (selfconsistent Hartree-Fock method).

Assume the existence of such a potential and construct it phenomenologically

Characteristics of the potential:

$$\left( \frac{\partial V(r)}{\partial r} \right)_{r=0} = 0 \quad \left( \frac{\partial V}{\partial r} \right)_{r < R_0} > 0 \quad V(r) \approx 0, \quad r > R_0$$

# Spherical potentials

## Infinite square well

$$V(r) = -V_0 \quad \text{for } r \leq R \\ = +\infty \quad \text{for } r > R$$

## Harmonic oscillator

$$V(r) = \frac{1}{2} M \omega_0^2 r^2$$

## Woods-Saxon potential

$$V(r) = -\frac{V_0}{1 + \exp\left[(r - R)/a\right]}$$

## Eigen-functions

$$\psi \sim j_\ell(kr) Y_{\ell m}(\Omega)$$

$$\psi \sim R_{nl}(r) Y_{\ell m}(\Omega)$$

$$R_{nl}(r) = r^\ell e^{-\frac{1}{2}r^2} L_{n-1}^{\ell+1/2}(r^2)$$

numerically

## Eigen-energies

$$E(n, \ell) = \frac{\hbar^2}{2MR^2} \xi_{nl}^2$$

$$\xi_{nl}: \text{root of } j_\ell(\xi) = 0$$

$$E(n, \ell) = \hbar\omega_0 (2n + \ell + 3/2)$$

$$= \hbar\omega_0 (N + 3/2)$$

intermediate

# Spherical potentials

## Woods-Saxon potential

$$V(r) = -\frac{V_0}{1 + \exp\left[\frac{r - R}{a}\right]}$$

## Harmonic oscillator

$$V(r) = \frac{1}{2} M \omega_0^2 r^2$$

## Infinite square well

$$V(r) = -V_0 \quad \text{for } r \leq R$$
$$= +\infty \quad \text{for } r > R$$

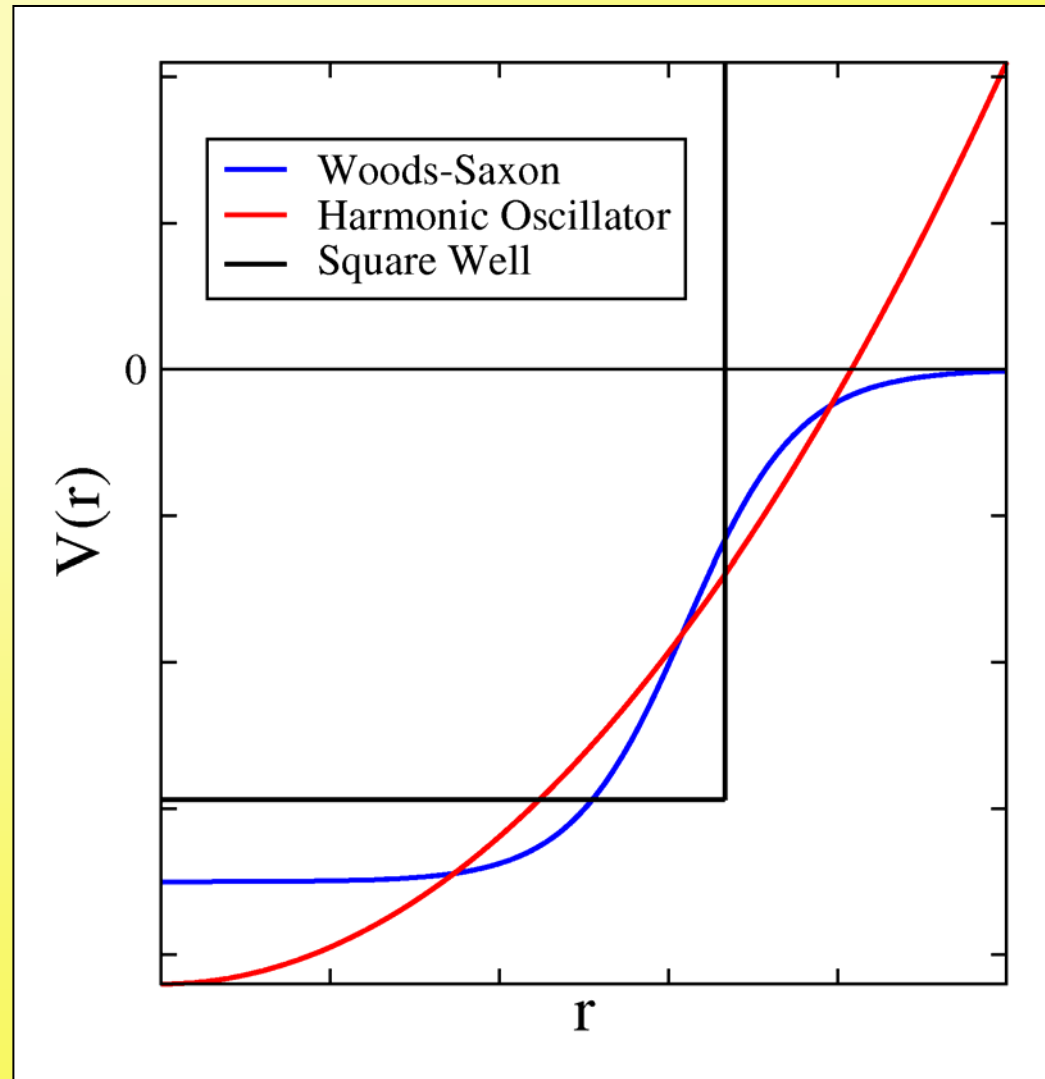

# Spherical potentials

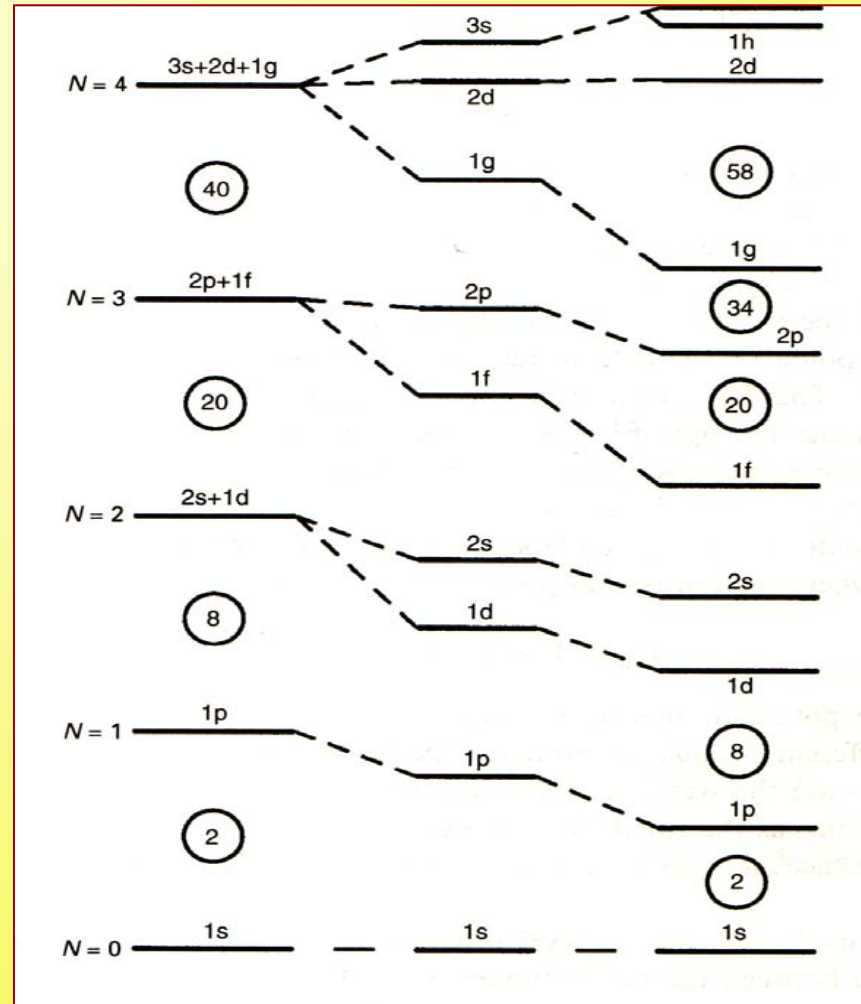

H.O.

W.S.

Square

# Spherical potentials & spin-orbit

$$V(r) = \frac{1}{2} M \omega_0^2 r^2 + C \vec{\ell} \cdot \vec{s} + D \vec{\ell}^2$$

$$\vec{\ell} \cdot \vec{s} = \frac{1}{2} (\vec{j}^2 - \vec{\ell}^2 - \vec{s}^2)$$

$$E(n, \ell) = \hbar \omega_0 (2n + \ell + 3/2) + D \ell(\ell + 1) + C \varepsilon_{SO}$$

$$\begin{cases} \varepsilon_{SO} = \ell & \text{for } j = \ell + \frac{1}{2} \\ \varepsilon_{SO} = -\ell - 1 & \text{for } j = \ell - \frac{1}{2} \end{cases}$$

$$\Delta \varepsilon_{SO} = 2\ell + 1$$

## Spherical mean-field

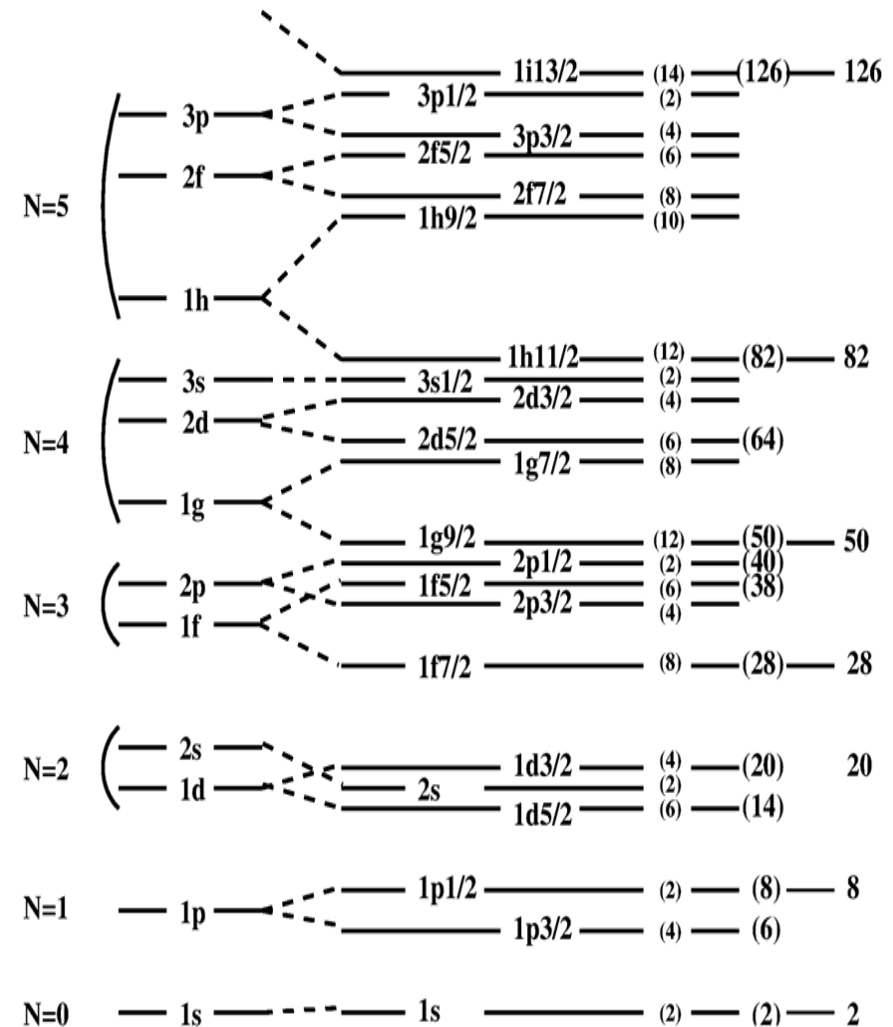

# Deformed shell model

Spherical potential well valid for closed shells

Far from closed shells: deformed single particle potential

Experimental evidence:

- Existence of rotational bands:  $I(I+1)$  spectra
- Large quadrupole moments and quadrupole transition probabilities
- Single particle structure

Anisotropic Harmonic Oscillator

Generalized Woods-Saxon

$$V(r, \theta, \varphi) = -V_0 \left[ 1 + \exp\left(\frac{r - R(\theta, \varphi)}{a(\theta, \varphi)}\right) \right]^{-1}$$

$$V_{LS} = \lambda \left( \vec{\nabla} V(r, \theta, \varphi) \wedge \vec{p} \right) \cdot \vec{s}$$

# Anisotropic Harmonic Oscillator

Ellipsoidal distribution: Anisotropic Harmonic Oscillator as average field

$$H_0 = -\frac{\hbar^2}{2m} \Delta + \frac{m}{2} (\omega_x^2 x^2 + \omega_y^2 y^2 + \omega_z^2 z^2)$$

Frequencies are proportional to the inverse of the ellipsoid axes

$$\omega_i = \omega_0 \frac{R_0}{a_i}$$

For axially symmetric shapes,  
we introduce the parameter  $\delta$

$$\delta = \frac{\omega_{\perp} - \omega_z}{\omega_0}$$

$$\left\{ \begin{array}{l} \omega_{\perp}^2 = \omega_x^2 = \omega_y^2 = \omega_0^2 \left( 1 + \frac{2}{3} \delta \right) \\ \omega_z^2 = \omega_0^2 \left( 1 - \frac{4}{3} \delta \right) \end{array} \right.$$

From volume conservation

$$\omega_x \omega_y \omega_z = (\omega_0^0)^3 \quad \omega_0(\delta) = \omega_0^0 \left[ 1 - \frac{4}{3} \delta^2 - \frac{16}{27} \delta^3 \right]^{-1/6}, \quad \delta \simeq 0.95 \beta$$



# Anisotropic Harmonic Oscillator

Introducing dimensionless coordinates through the oscillator length

$$b(\delta) = \sqrt{\frac{\hbar}{m\omega_0(\delta)}} \quad \vec{r}' = \vec{r}/b$$

we get

$$\begin{aligned} H_0(\delta) &= -\frac{\hbar^2}{2m} \frac{m\omega_0(\delta)}{\hbar} \Delta + \frac{m}{2} \left[ \omega_0^2(\delta) \frac{\hbar}{m\omega_0} \left(1 + \frac{2}{3}\delta\right) (x^2 + y^2) + \omega_0^2(\delta) \frac{\hbar}{m\omega_0} \left(1 - \frac{4}{3}\delta\right) z^2 \right] \\ &= -\frac{\hbar\omega_0(\delta)}{2} \Delta + \frac{\hbar\omega_0(\delta)}{2} \left[ x^2 + y^2 + z^2 + \frac{2}{3}\delta(x^2 + y^2) - \frac{4}{3}\delta z^2 \right] \\ &= \frac{\hbar\omega_0(\delta)}{2} [-\Delta + r^2] - \delta\hbar\omega_0(\delta) \frac{4}{3} \sqrt{\frac{\pi}{5}} r^2 Y_{20}(\Omega) \\ &= \overset{0}{H}_0 + H_\delta \end{aligned}$$

Axial symmetry: cylindrical basis

$$\{N, n_z, n_\rho, m_\ell, m_s\}$$

$$N = n_x + n_y + n_z = n_z + 2n_\rho + m_\ell$$

$$\begin{aligned} \varepsilon(n_z, n_\rho, m_\ell) &= \sum_{i=x,y,z} \hbar\omega_i \left( n_i + \frac{1}{2} \right) = \hbar\omega_z \left( n_z + \frac{1}{2} \right) + \hbar\omega_\perp (2n_\rho + m_\ell + 1) \\ &= \overset{0}{\hbar\omega_0} \left[ \left( N + \frac{3}{2} \right) + \delta \left( \frac{N}{3} - n_z \right) \right] \end{aligned}$$

# Anisotropic Harmonic Oscillator

Eigen-states characterized by  $\Omega\pi [Nn_z m_\ell]$   $\Omega = m_\ell \pm \frac{1}{2}$   $\pi = (-1)^N$

$$\phi_{n_z n_\rho m_\ell m_s}(\vec{R}, \sigma) = \psi_{n_\rho}^{m_\ell}(\rho) \psi_{n_z}(z) \frac{e^{im_\ell \varphi}}{\sqrt{2\pi}} \chi_{m_s}(\sigma)$$

$$\psi_{n_\rho}^{m_\ell}(\rho) \sim L_{n_\rho}^{m_\ell}(\rho)$$

$$\psi_{n_z}(z) \sim H_{n_z}(z)$$

# Anisotropic Harmonic Oscillator

## Energy level structure: N=3

$$\begin{aligned}\varepsilon(n_z, n_\rho, m_\ell) &= \sum_{i=x,y,z} \hbar\omega_i \left( n_i + \frac{1}{2} \right) = \hbar\omega_z \left( n_z + \frac{1}{2} \right) + \hbar\omega_\perp (2n_\rho + m_\ell + 1) \\ &= \hbar\omega_0^0 \left[ \left( N + \frac{3}{2} \right) + \delta \left( \frac{N}{3} - n_z \right) \right]\end{aligned}$$

$$N = n_z + 2n_\rho + m_\ell$$

$$\varepsilon^{N=3}(n_z, n_\rho, m_\ell) = \frac{9}{2} \hbar\omega_0^0 + \hbar\omega_0^0 \delta(1 - n_z)$$

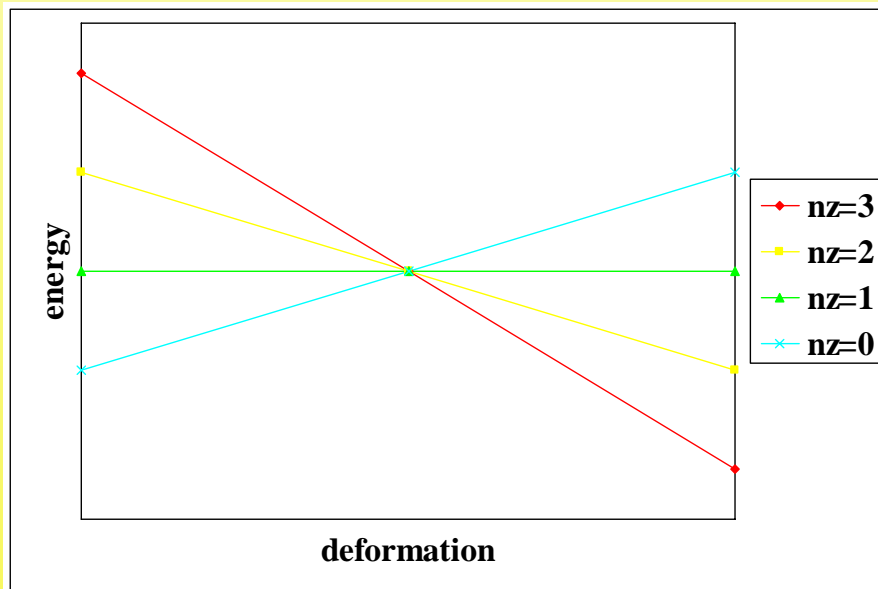

$n_z$	$m_\ell$	$n_\rho$	$\Omega$	deg
0	3	0	5/2, 7/2	4
	1	1	1/2, 3/2	
1	2	0	3/2, 5/2	3
	0	1	1/2	
2	1	0	1/2, 3/2	2
3	0	0	1/2	1

# The Nilsson model: Hamiltonian

Axially symmetric harmonic oscillator potential

+spin-orbit term

+ $l^2$  term

$$\begin{aligned} H &= H_0 + C \vec{\ell} \cdot \vec{s} + D \left( \vec{\ell}^2 - \langle \vec{\ell}^2 \rangle_N \right) \\ &= \hbar \omega_0 (\delta) \left[ -\frac{1}{2} \Delta + \frac{1}{2} r^2 - \beta r^2 Y_{20} \right] - \kappa \hbar \omega_0 \left[ 2 \vec{\ell} \cdot \vec{s} + \mu \left( \vec{\ell}^2 - \langle \vec{\ell}^2 \rangle_N \right) \right] \\ C &= -2\kappa \hbar \omega_0^0 \\ D &= -\kappa \mu \hbar \omega_0^0 \end{aligned}$$

$$\langle \vec{\ell}^2 \rangle_N = \frac{1}{2} N(N+3)$$

# The Nilsson model: Hamiltonian

$$H = H_0^0 + \kappa \hbar \omega_0 F$$

$$F = \frac{\delta}{\kappa} \left[ 1 - \frac{4}{3} \delta^2 - \frac{16}{27} \delta^3 \right]^{-1/6} \left\{ -\frac{4}{3} \sqrt{\frac{\pi}{5}} r^2 Y_{20} \right\} - 2 \vec{\ell} \cdot \vec{s} - \mu \left( \vec{\ell}^2 - \langle \vec{\ell}^2 \rangle_N \right)$$

$$F = \eta U - 2 \vec{\ell} \cdot \vec{s} - \mu \left( \vec{\ell}^2 - \langle \vec{\ell}^2 \rangle_N \right)$$

$$E = \left( N + \frac{3}{2} \right) \hbar \omega_0 (\delta) + \kappa \hbar \omega_0 f$$

	N,Z<50	50<Z<82	82<N<126	82<Z	126<N
$\kappa$	0.08	0.0637	0.0637	0.0577	0.0635
$\mu$	0	0.60	0.42	0.65	0.325

# The Nilsson model: Basis

$\vec{\ell} \cdot \vec{s}$  and  $\vec{\ell}^2$  nondiagonal in basis  $\{N, n_z, n_\rho, m_\ell, m_s\}$

For large deformations  $\vec{\ell} \cdot \vec{s}$ ,  $\vec{\ell}^2$  can be neglected:

Asymptotic quantum numbers  $\{N, n_z, n_\rho, m_\ell, m_s\}$ :  $[N n_z m_\ell] \Omega \pi$

For small deformations  $\delta$ -terms can be neglected:

Spherical basis  $\{N, \ell, j, \Omega\}$

Nilsson used basis  $\{N, \ell, m_\ell, m_s\}$

Diagonal terms

$$H_0^0 |N, \ell, m_\ell, m_s\rangle = \left(N + \frac{3}{2}\right) \hbar \omega_0^0 |N, \ell, m_\ell, m_s\rangle$$

$$\vec{\ell}^2 |N, \ell, m_\ell, m_s\rangle = \ell(\ell + 1) |N, \ell, m_\ell, m_s\rangle$$

# The Nilsson model: Matrix elements

## Matrix elements

$$\langle \ell' m'_\ell m'_s | \vec{l} \cdot \vec{s} | \ell m_\ell m_s \rangle \left\{ \begin{array}{l} \ell = \ell' \\ m_\ell = m'_\ell, m'_\ell \pm 1 \\ m_s = m'_s \pm 1, m'_s \\ m_\ell + m_s = m'_\ell + m'_s \end{array} \right.$$

$$\langle \ell, m_\ell \pm 1, \mp | \vec{l} \cdot \vec{s} | \ell, m_\ell, \pm \rangle = \frac{1}{2} \sqrt{(\ell \mp m_\ell)(\ell \pm m_\ell + 1)}$$

$$\langle \ell, m_\ell, \pm | \vec{l} \cdot \vec{s} | \ell, m_\ell, \pm \rangle = \pm \frac{1}{2} m_\ell$$

$$\langle \ell' m'_\ell | Y_{20} | \ell m_\ell \rangle = i^{\ell-\ell'} \sqrt{\frac{5}{4\pi}} \sqrt{\frac{2\ell+1}{2\ell'+1}} \langle \ell 2 m_\ell 0 | \ell 2 \ell' m'_\ell \rangle \langle \ell 2 0 0 | \ell 2 \ell' 0 \rangle$$

$$\left\{ \begin{array}{l} m_\ell = m'_\ell \quad m_s = m'_s \\ \ell = \ell', \ell' \pm 2 \quad N = N' \pm 2 \end{array} \right.$$

# The Nilsson model: Matrix elements

Radial matrix elements

$$|N\ell\rangle = \sqrt{\frac{2(n-1)!}{b^3 [\Gamma(n+\ell+1/2)]^3}} \left(\frac{r}{b}\right)^\ell e^{-\frac{1}{2}\left(\frac{r}{b}\right)^2} L_{n-1}^{\ell+1/2}(r^2/b^2)$$

$$\langle N'\ell'|r^2|N\ell\rangle = \left[ \frac{(n'-1)!(n-1)!}{[\Gamma(n'+\ell'+1/2)][\Gamma(n+\ell+1/2)]} \right]^{1/2} b^2 (-1)^{n'+n} \mu! \nu!$$

$$\times \sum_{\sigma} \frac{\Gamma(p+\sigma+1)}{\sigma!(n'-1-\sigma)!(n-1-\sigma)!(\sigma+\mu-n'+1)!(\sigma+\nu-n+1)!}$$

$$p = \frac{1}{2}(\ell+\ell'+3) \quad \mu = p - \ell' - 1/2 \quad \nu = p - \ell - 1/2$$

$$N = 2(n-1) + \ell$$

$N, N \pm 2$  admixtures

$$\left\{ \begin{aligned} \langle N\ell|r^2|N\ell\rangle &= (2n + \ell - 1/2) = (N + 3/2) \\ \langle N\ell - 2|r^2|N\ell\rangle &= 2\sqrt{n(n + \ell - 1/2)} \\ \langle N - 2\ell|r^2|N\ell\rangle &= -\sqrt{(n-1)(n + \ell - 1/2)} \\ \langle N - 2\ell - 2|r^2|N\ell\rangle &= \sqrt{(n + \ell - 1/2)(n + \ell - 3/2)} \\ \langle N - 2\ell + 2|r^2|N\ell\rangle &= \sqrt{(n-1)(n-2)} \end{aligned} \right.$$



# The Nilsson model

**Nilsson states:**  $|i\rangle_{\{\Omega\pi\}} = \sum_{\alpha} C_i^{\alpha} |\alpha\rangle; \quad \alpha \{N \ell m_{\ell} m_s\}$

$N$	$\Omega$	$ N \ell m_{\ell} m_s\rangle_{\Omega\pi}$
$N = 0$	$\Omega = 1/2$	$ 000+\rangle_{1/2^+}$
$N = 1$	$\Omega = 3/2$	$ 111+\rangle_{3/2^-}$
	$\Omega = 1/2$	$ 110+\rangle_{1/2^-} \quad  111-\rangle_{1/2^-}$
$N = 2$	$\Omega = 5/2$	$ 222+\rangle_{5/2^+}$
	$\Omega = 3/2$	$ 221+\rangle_{3/2^+} \quad  222-\rangle_{3/2^+}$
	$\Omega = 1/2$	$ 220+\rangle_{5/2^+} \quad  200+\rangle_{5/2^+} \quad  221-\rangle_{5/2^+}$
$N = 3$	$\Omega = 7/2$	$ 333+\rangle_{7/2^-}$
	$\Omega = 5/2$	$ 332+\rangle_{5/2^-} \quad  333-\rangle_{5/2^-}$
	$\Omega = 3/2$	$ 331+\rangle_{3/2^-} \quad  311+\rangle_{3/2^-} \quad  332-\rangle_{3/2^-}$
	$\Omega = 1/2$	$ 330+\rangle_{1/2^-} \quad  331+\rangle_{3/2^-} \quad  331-\rangle_{1/2^-} \quad  311-\rangle_{1/2^-}$

# The Nilsson model: $N=0$

Diagonalization in blocks  $\Omega, \pi$  (with or without  $\Delta N=2$  admixtures)

$$H = H_0^0 + \kappa \hbar \omega_0^0 F = H_0^0 + \kappa \hbar \omega_0^0 \left\{ \eta U - 2\vec{\ell} \cdot \vec{s} - \mu \vec{\ell}^2 \right\}$$

$$\eta = \frac{\delta}{\kappa} \left[ 1 - \frac{4}{3} \delta^2 - \frac{16}{27} \delta^3 \right]^{-1/6} \quad U = \left\{ -\frac{4}{3} \sqrt{\frac{\pi}{5}} r^2 Y_{20} \right\}$$

$$N=0 \quad \Omega=1/2 \quad \rightarrow \quad n=1, l=0$$

$$|N \ell m_\ell m_s\rangle \quad \rightarrow \quad |000+\rangle$$

$$N=0 \quad \rightarrow \quad \mu=0$$

$$\langle 000+ | \vec{\ell} \cdot \vec{s} | 000+ \rangle = 0$$

$$\langle 000+ | Y_{20} | 000+ \rangle \sim \begin{pmatrix} 0 & 2 & 0 \\ 0 & 0 & 0 \end{pmatrix} = 0$$

$$\langle 000+ | \eta U - 2\vec{\ell} \cdot \vec{s} - \mu \vec{\ell}^2 | 000+ \rangle = 0$$

# The Nilsson model: N=1

$$N=1 \quad \Omega=3/2 \quad \rightarrow \quad n=1, \ell=1$$

$$|N\ell m_\ell m_s\rangle \quad \rightarrow \quad |111+\rangle$$

$$N=1 \quad \Omega=1/2 \quad \rightarrow \quad n=1, \ell=1$$

$$|N\ell m_\ell m_s\rangle \quad \rightarrow \quad |110+\rangle, |111-\rangle$$

$$N=1 \rightarrow \mu=0$$

$$\langle 111+ | \vec{\ell} \cdot \vec{s} | 111+ \rangle = \frac{1}{2}$$

$$\langle 111+ | -\eta \frac{4}{3} \sqrt{\frac{\pi}{5}} r^2 Y_{20} | 111+ \rangle = -\eta \frac{4}{3} \sqrt{\frac{\pi}{5}} \langle 11 | r^2 | 11 \rangle \langle 11 | Y_{20} | 11 \rangle = \frac{1}{3} \eta$$

$$\langle 11 | r^2 | 11 \rangle = 1 + \frac{3}{2}$$

$$\langle 11 | Y_{20} | 11 \rangle = \sqrt{\frac{5}{4\pi}} \langle 1210 | 1211 \rangle \langle 1200 | 1210 \rangle = -\sqrt{\frac{5}{4\pi}} \frac{1}{5}$$

$$\langle 111+ | \eta U - 2\vec{\ell} \cdot \vec{s} - \mu \vec{\ell}^2 | 111+ \rangle = \frac{1}{3} \eta - 1$$

$$N=1 \rightarrow \mu=0$$

$$\langle 110+ | \vec{\ell} \cdot \vec{s} | 110+ \rangle = 0$$

$$\langle 110+ | -\eta \frac{4}{3} \sqrt{\frac{\pi}{5}} r^2 Y_{20} | 110+ \rangle = -\eta \frac{4}{3} \sqrt{\frac{\pi}{5}} \langle 11 | r^2 | 11 \rangle \langle 10 | Y_{20} | 10 \rangle = -\frac{2}{3} \eta$$

$$\langle 11 | r^2 | 11 \rangle = 1 + \frac{3}{2}$$

$$\langle 10 | Y_{20} | 10 \rangle = \sqrt{\frac{5}{4\pi}} \langle 1200 | 1210 \rangle \langle 1200 | 1210 \rangle = \sqrt{\frac{5}{4\pi}} \frac{2}{5}$$

$$\langle 110+ | \eta U - 2\vec{\ell} \cdot \vec{s} - \mu \vec{\ell}^2 | 110+ \rangle = -\frac{2}{3} \eta$$

$$\langle 111- | \eta U - 2\vec{\ell} \cdot \vec{s} - \mu \vec{\ell}^2 | 111- \rangle = 1 + \frac{1}{3} \eta$$

$$\langle 110+ | \eta U - 2\vec{\ell} \cdot \vec{s} - \mu \vec{\ell}^2 | 111- \rangle = -\sqrt{2}$$

$$|110+\rangle \quad |111-\rangle$$

$$\begin{pmatrix} -\frac{2}{3}\eta & -\sqrt{2} \\ -\sqrt{2} & 1 + \frac{1}{3}\eta \end{pmatrix}$$

$$\lambda = \frac{1 - \frac{1}{3}\eta \pm \sqrt{\eta^2 + 2\eta + 9}}{2}$$

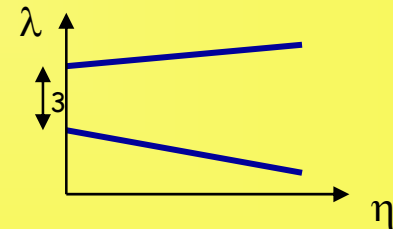

# The Nilsson model: N=2

$$N=2 \quad \Omega=5/2 \rightarrow \{n=1, \ell=2\} \{n=2, \ell=0\}$$

$$|N\ell m_\ell m_s\rangle \rightarrow |222+\rangle$$

$$\langle 222+ | \eta U - 2\vec{\ell} \cdot \vec{s} - \mu \vec{\ell}^2 | 222+\rangle = -2 + \frac{2}{3}\eta$$

$$N=2 \quad \Omega=3/2$$

$$|N\ell m_\ell m_s\rangle \rightarrow |221+\rangle, |222-\rangle$$

$$\langle 221+ | \eta U - 2\vec{\ell} \cdot \vec{s} - \mu \vec{\ell}^2 | 221+\rangle = -1 - \frac{1}{3}\eta$$

$$\langle 222- | \eta U - 2\vec{\ell} \cdot \vec{s} - \mu \vec{\ell}^2 | 222-\rangle = 2 + \frac{2}{3}\eta$$

$$\langle 222- | \eta U - 2\vec{\ell} \cdot \vec{s} - \mu \vec{\ell}^2 | 221+\rangle = -2$$

$$\begin{array}{cc} |221+\rangle & |222-\rangle \\ \left( \begin{array}{cc} -\left(1 + \frac{1}{3}\eta\right) & -2 \\ -2 & 2 + \frac{2}{3}\eta \end{array} \right) \end{array}$$

$$N=2 \quad \Omega=1/2$$

$$|N\ell m_\ell m_s\rangle \rightarrow |220+\rangle, |200+\rangle, |221-\rangle$$

$$\langle 220+ | \eta U - 2\vec{\ell} \cdot \vec{s} - \mu \vec{\ell}^2 | 220+\rangle = -\frac{2}{3}\eta$$

$$\langle 200+ | \eta U - 2\vec{\ell} \cdot \vec{s} - \mu \vec{\ell}^2 | 200+\rangle = 0$$

$$\langle 221- | \eta U - 2\vec{\ell} \cdot \vec{s} - \mu \vec{\ell}^2 | 221+\rangle = 1 - \frac{1}{3}\eta$$

$$\langle 220+ | \eta U - 2\vec{\ell} \cdot \vec{s} - \mu \vec{\ell}^2 | 200+\rangle = \frac{2\sqrt{2}}{3}\eta$$

$$\langle 220+ | \eta U - 2\vec{\ell} \cdot \vec{s} - \mu \vec{\ell}^2 | 221-\rangle = -\sqrt{6}$$

$$\langle 200+ | \eta U - 2\vec{\ell} \cdot \vec{s} - \mu \vec{\ell}^2 | 221-\rangle = 0$$

$$\begin{array}{ccc} |220+\rangle & |200+\rangle & |221-\rangle \\ \left( \begin{array}{ccc} -\frac{2}{3}\eta & \frac{2\sqrt{2}}{3}\eta & -\sqrt{6} \\ & 0 & 0 \\ & & 1 - \frac{1}{3}\eta \end{array} \right) \end{array}$$

# The Nilsson model: $N=3$

$$N=3 \quad \Omega=7/2$$

$$\begin{array}{l} |333+\rangle \\ (\eta-3-12\mu) \end{array}$$

$$N=3 \quad \Omega=5/2$$

$$\begin{array}{cc} |332+\rangle & |333-\rangle \\ \left( \begin{array}{cc} -1-12\mu & -\sqrt{6} \\ & \eta+3-12\mu \end{array} \right) \end{array}$$

$$N=3 \quad \Omega=3/2$$

$$\begin{array}{ccc} |331+\rangle & |311+\rangle & |332-\rangle \\ \left( \begin{array}{ccc} -\frac{3}{5}\eta-1-12\mu & \frac{4}{5}\eta & -\sqrt{10} \\ & \frac{3}{5}\eta-1-2\mu & 0 \\ & & 2-12\mu \end{array} \right) \end{array}$$

$$N=3 \quad \Omega=1/2$$

$$\begin{array}{cccc} |330+\rangle & |310+\rangle & |331-\rangle & |311-\rangle \\ \left( \begin{array}{cccc} -\frac{4}{5}\eta-12\mu & \frac{2\sqrt{6}}{5}\eta & -2\sqrt{3} & 0 \\ & -\frac{6}{5}\eta-2\mu & 0 & -\sqrt{2} \\ & & -\frac{3}{5}\eta+1-12\mu & \frac{4}{5}\eta \\ & & & \frac{3}{5}\eta+1-2\mu \end{array} \right) \end{array}$$

# The Nilsson model: $\Delta N=2$

$\Omega=1/2^+$  with  $\Delta N=2$  admixtures

	$ 000+\rangle$	$ 220+\rangle$	$ 200+\rangle$	$ 221-\rangle$	$ 440+\rangle$	$ 420+\rangle$	$ 400+\rangle$	$ 441-\rangle$	$ 421-\rangle$
$ 000+\rangle$	0	$\frac{1}{\sqrt{3}}\eta$	0	0	0	0	0	0	0
$ 220+\rangle$		$-\frac{2}{3}\eta$	$-\frac{2\sqrt{2}}{3}\eta$	$-\sqrt{6}$	$\frac{6}{\sqrt{35}}\eta$	$\frac{2}{3}\sqrt{\frac{2}{7}}\eta$	$\frac{2}{3}\sqrt{\frac{2}{5}}\eta$	0	0
$ 200+\rangle$			0	0	0	$\frac{1}{3}\sqrt{7}\eta$	0	0	0
$ 221-\rangle$				$-\frac{1}{3}\eta+1$	0	0	0	$\sqrt{\frac{6}{7}}\eta$	$\frac{1}{3}\sqrt{\frac{2}{7}}\eta$
$ 440+\rangle$					$-\frac{20}{21}\eta-20\mu$	$\frac{12\sqrt{10}}{35}\eta$	0	$-\sqrt{20}$	0
$ 420+\rangle$						$-\frac{22}{21}\eta-6\mu$	$\frac{4}{15}\sqrt{35}\eta$	0	$-\sqrt{6}$
$ 400+\rangle$							0	0	0
$ 441-\rangle$								$-\frac{17}{21}\eta+1-20\mu$	$\frac{4}{7}\sqrt{3}\eta$
$ 421-\rangle$									$-\frac{11}{21}\eta+1-6\mu$

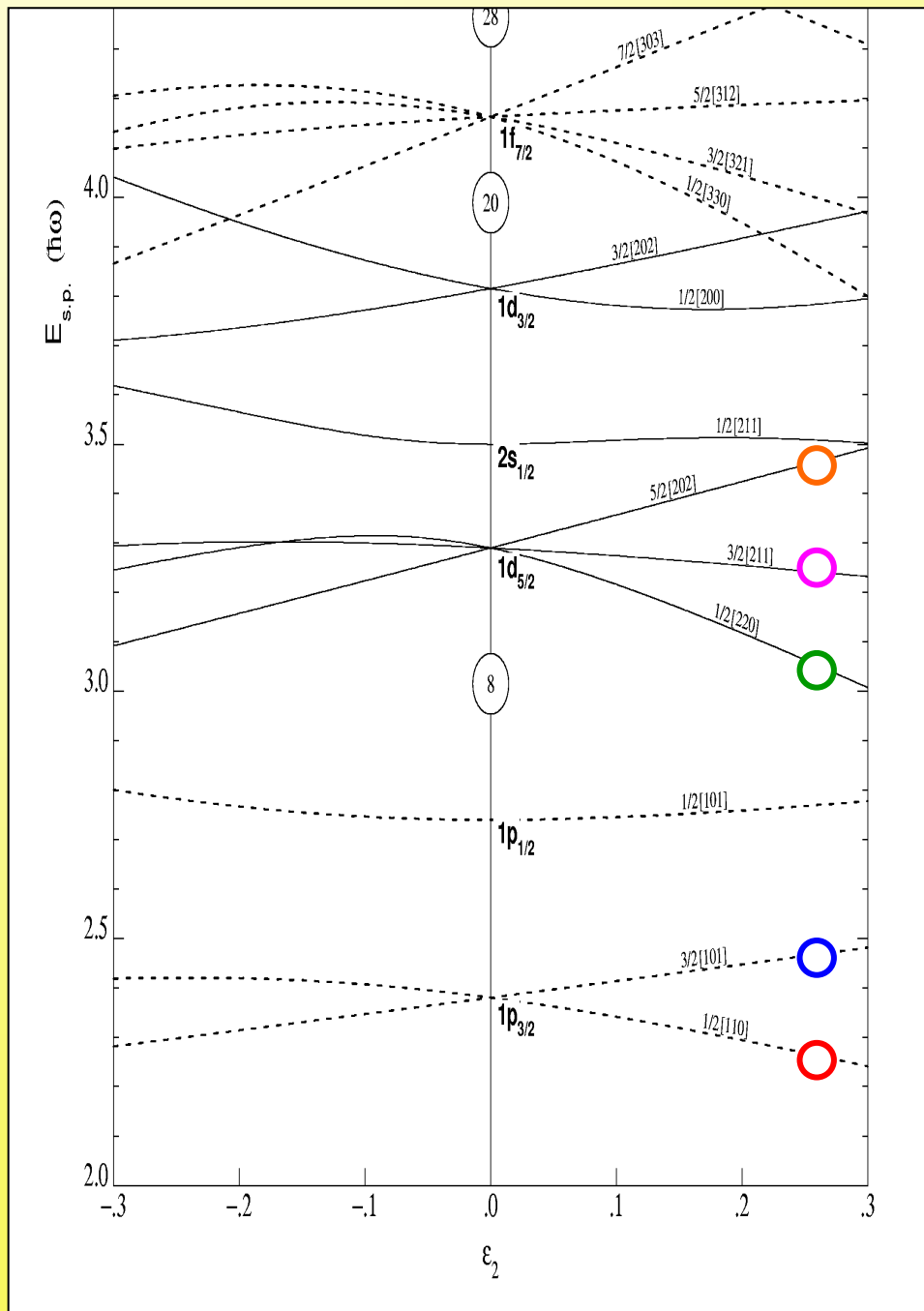

$${}^A_Z \text{Nucleus}_N \rightarrow K^\pi$$

- ${}^{27}_{13} \text{Al}_{14} \rightarrow 5/2^+$        ${}^{27}_{14} \text{Si}_{13} \rightarrow 5/2^+$   
 ${}^{25}_{12} \text{Mg}_{13} \rightarrow 5/2^+$   
 ${}^{23}_{11} \text{Na}_{12} \rightarrow 3/2^+$        ${}^{19}_8 \text{O}_{11} \rightarrow 3/2^+$   
 ${}^{19}_9 \text{F}_{10} \rightarrow 1/2^+$        ${}^{19}_{10} \text{Ne}_9 \rightarrow 1/2^+$   
 ${}^9_4 \text{Be}_5 \rightarrow 3/2^-$   
 ${}^7_3 \text{Li}_4 \rightarrow 1/2^-$

- Spherical levels split into  $(2j+1)/2$  levels
- Levels  $(\Omega\pi)$  are twofold degenerate
- Asymptotic q-numbers not conserved for small deformations but useful to classify levels
- For positive deformations (PROLATE SHAPES), levels with lower  $\Omega$  are shifted downwards
- For negative deformations (OBLATE SHAPES), levels with lower  $\Omega$  are shifted upwards

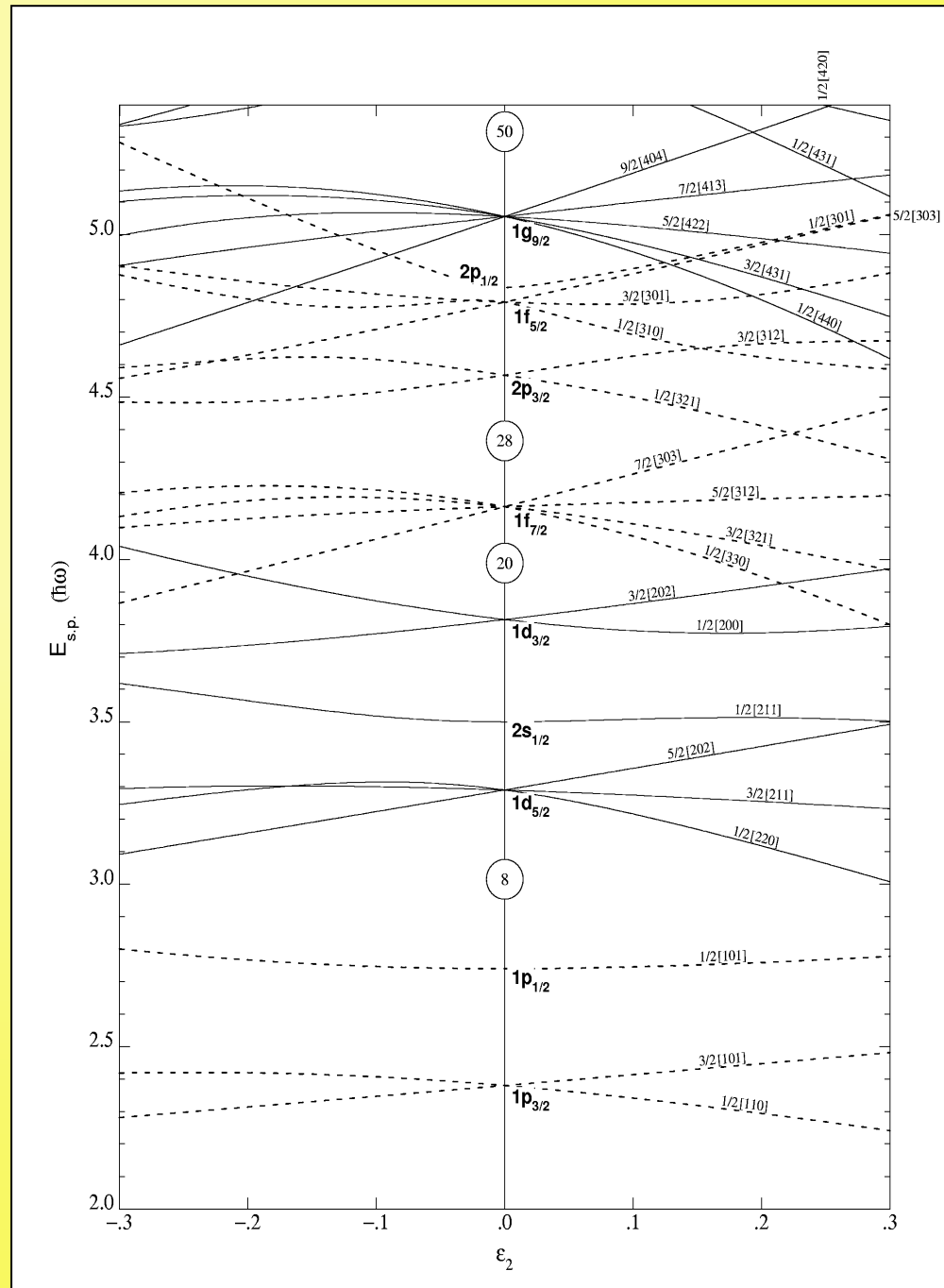



$$N = n_z + 2n_\rho + m_\ell$$

$$[Nn_zm_\ell]\Omega^\pi$$

$$N = 0 \quad \Omega = 1/2^+ \quad n_z = 0 \quad m_\ell = 0 \quad [000]1/2^+$$

$$N = 1 \quad \Omega = 1/2^- \quad n_z = 1 \quad m_\ell = 0 \quad [110]1/2^-$$

$$n_z = 0 \quad m_\ell = 1 \quad [101]1/2^-$$

$$N = 1 \quad \Omega = 3/2^- \quad n_z = 0 \quad m_\ell = 1 \quad [101]3/2^-$$

$$N = 2 \quad \Omega = 1/2^+ \quad n_z = 2 \quad m_\ell = 0 \quad [220]1/2^+$$

$$n_z = 1 \quad m_\ell = 1 \quad [211]1/2^+$$

$$n_z = 0 \quad m_\ell = 0 \quad [200]1/2^+$$

$$N = 2 \quad \Omega = 3/2^+ \quad n_z = 1 \quad m_\ell = 1 \quad [211]3/2^+$$

$$n_z = 0 \quad m_\ell = 2 \quad [202]3/2^+$$

$$N = 2 \quad \Omega = 5/2^+ \quad n_z = 0 \quad m_\ell = 2 \quad [202]5/2^+$$

$$N = 3 \quad \Omega = 1/2^- \quad n_z = 3 \quad m_\ell = 0 \quad [330]1/2^-$$

$$n_z = 2 \quad m_\ell = 1 \quad [321]1/2^-$$

$$n_z = 1 \quad m_\ell = 0 \quad [310]1/2^-$$

$$n_z = 0 \quad m_\ell = 1 \quad [301]1/2^-$$

$$N = 3 \quad \Omega = 3/2^- \quad n_z = 2 \quad m_\ell = 1 \quad [321]3/2^-$$

$$n_z = 1 \quad m_\ell = 2 \quad [312]3/2^-$$

$$n_z = 0 \quad m_\ell = 1 \quad [301]3/2^-$$

$$N = 3 \quad \Omega = 5/2^- \quad n_z = 1 \quad m_\ell = 2 \quad [312]5/2^-$$

$$n_z = 0 \quad m_\ell = 3 \quad [303]5/2^-$$

$$N = 3 \quad \Omega = 7/2^- \quad n_z = 0 \quad m_\ell = 3 \quad [303]7/2^-$$

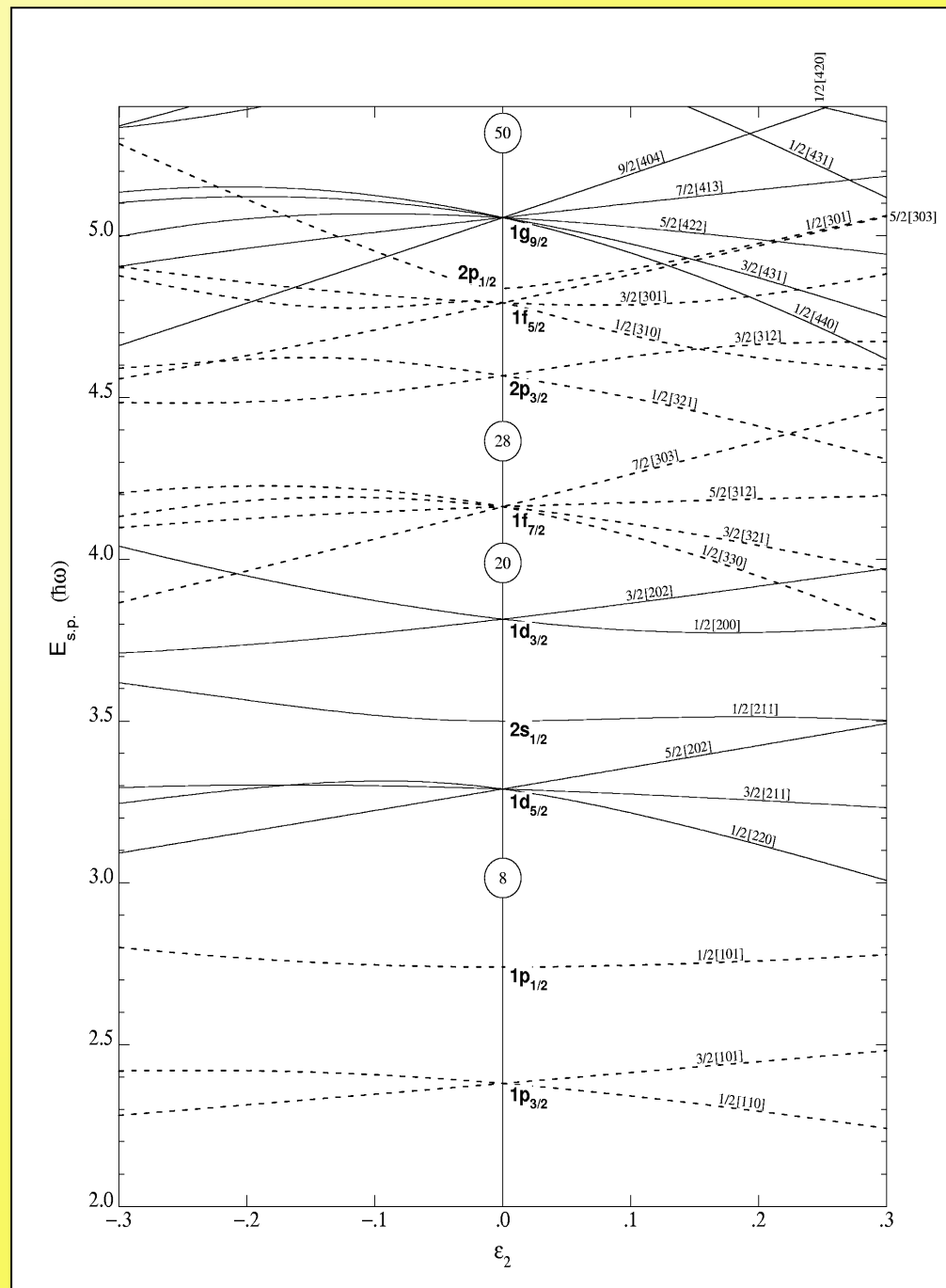

# Laboratory frame

Wave functions in the unified model

$$\Psi \sim \phi(\vec{r}) \Phi(\theta_k)$$

$$\Psi(IKM) = \sqrt{\frac{2I+1}{16\pi^2}} \left\{ D_{MK}^{I*}(\theta_k) \phi_K(\vec{r}) + (-1)^{I-J} D_{M-K}^{I*}(\theta_k) \phi_{-K}(\vec{r}) \right\}$$

Intrinsic wave functions (Nilsson)

Rotation matrices

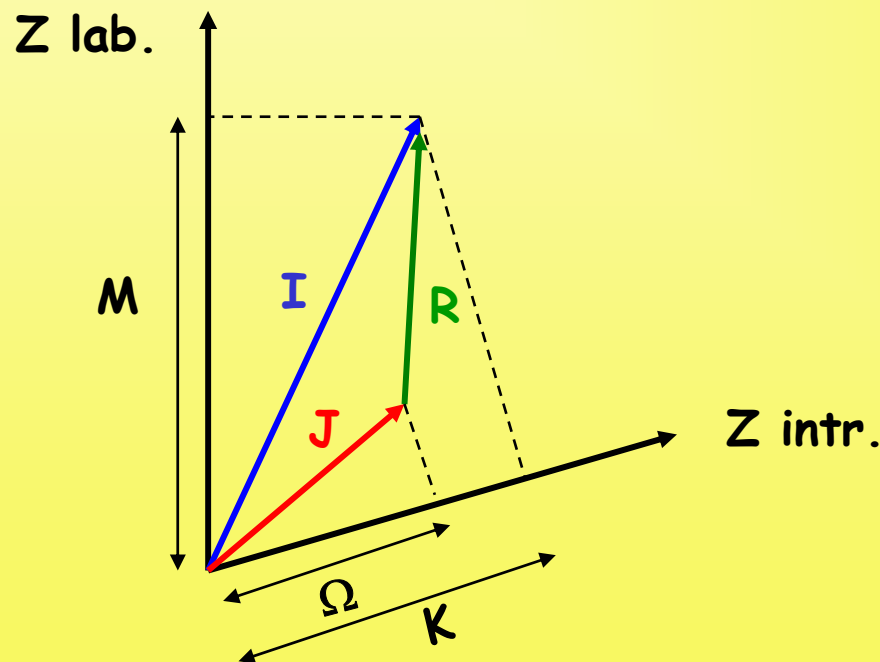

# 3-j

$$\begin{array}{l}
 \left( \begin{array}{ccc} a & a+\frac{1}{2} & \frac{1}{2} \\ \alpha & -\alpha-\frac{1}{2} & \frac{1}{2} \end{array} \right) = (-)^{a-\alpha-1} \left[ \frac{a+\alpha+1}{(2a+2)(2a+1)} \right]^{\frac{1}{2}} \\
 \left( \begin{array}{ccc} a & a & 1 \\ \alpha & -\alpha-1 & 1 \end{array} \right) = (-)^{a-\alpha} \left[ \frac{(a-\alpha)(a+\alpha+1)}{2a(a+1)(2a+1)} \right]^{\frac{1}{2}} \\
 \left( \begin{array}{ccc} a & a & 1 \\ \alpha & -\alpha & 0 \end{array} \right) = (-)^{a-\alpha} \frac{\alpha}{[a(a+1)(2a+1)]^{\frac{1}{2}}} \\
 \left( \begin{array}{ccc} a & a+1 & 1 \\ \alpha & -\alpha-1 & 1 \end{array} \right) = (-)^{a-\alpha} \left[ \frac{(a+\alpha+1)(a+\alpha+2)}{(2a+1)(2a+2)(2a+3)} \right]^{\frac{1}{2}} \\
 \left( \begin{array}{ccc} a & a+1 & 1 \\ \alpha & -\alpha & 0 \end{array} \right) = (-)^{a-\alpha-1} \left[ \frac{(a-\alpha+1)(a+\alpha+1)}{(a+1)(2a+1)(2a+3)} \right]^{\frac{1}{2}} \\
 \left( \begin{array}{ccc} a & a+\frac{1}{2} & \frac{3}{2} \\ \alpha & -\alpha-\frac{3}{2} & \frac{3}{2} \end{array} \right) = (-)^{a-\alpha-1} \left[ \frac{3(a+\alpha+1)(a+\alpha+2)(a-\alpha)}{2a(2a+1)(2a+2)(2a+3)} \right]^{\frac{1}{2}} \\
 \left( \begin{array}{ccc} a & a+\frac{1}{2} & \frac{3}{2} \\ \alpha & -\alpha-\frac{1}{2} & \frac{1}{2} \end{array} \right) = (-)^{a-\alpha} \left[ \frac{a+\alpha+1}{2a(2a+1)(2a+2)(2a+3)} \right]^{\frac{1}{2}} (a-3\alpha) \\
 \left( \begin{array}{ccc} a & a+\frac{3}{2} & \frac{5}{2} \\ \alpha & -\alpha-\frac{3}{2} & \frac{5}{2} \end{array} \right) = (-)^{a-\alpha-1} \left[ \frac{(a+\alpha+1)(a+\alpha+2)(a+\alpha+3)}{(2a+1)(2a+2)(2a+3)(2a+4)} \right]^{\frac{1}{2}} \\
 \left( \begin{array}{ccc} a & a+\frac{3}{2} & \frac{1}{2} \\ \alpha & -\alpha-\frac{1}{2} & \frac{1}{2} \end{array} \right) = (-)^{a-\alpha} \left[ \frac{3(a-\alpha+1)(a+\alpha+1)(a+\alpha+2)}{(2a+1)(2a+2)(2a+3)(2a+4)} \right]^{\frac{1}{2}} \\
 \left( \begin{array}{ccc} a & a & 2 \\ \alpha & -\alpha-2 & 2 \end{array} \right) = (-)^{a-\alpha} \left[ \frac{3(a+\alpha+1)(a+\alpha+2)(a-\alpha-1)(a-\alpha)}{a(2a+3)(2a+2)(2a+1)(2a-1)} \right]^{\frac{1}{2}} \\
 \left( \begin{array}{ccc} a & a & 2 \\ \alpha & -\alpha-1 & 1 \end{array} \right) = (-)^{a-\alpha} \left[ \frac{3(a-\alpha)(a+\alpha+1)}{a(2a+3)(2a+2)(2a+1)(2a-1)} \right]^{\frac{1}{2}} (2\alpha+1) \\
 \left( \begin{array}{ccc} a & a & 2 \\ \alpha & -\alpha & 0 \end{array} \right) = (-)^{a-\alpha} \frac{3\alpha^2 - a(a+1)}{[a(a+1)(2a+3)(2a+1)(2a-1)]^{\frac{1}{2}}} \\
 \left( \begin{array}{ccc} a & a+1 & 2 \\ \alpha & -\alpha-2 & 2 \end{array} \right) = (-)^{a-\alpha} \left[ \frac{(a+\alpha+1)(a+\alpha+2)(a+\alpha+3)(a-\alpha)}{a(a+1)(2a+4)(2a+3)(2a+1)} \right]^{\frac{1}{2}} \\
 \left( \begin{array}{ccc} a & a+1 & 2 \\ \alpha & -\alpha-1 & 1 \end{array} \right) = (-)^{a-\alpha-1} \left[ \frac{(a+\alpha+2)(a+\alpha+1)}{a(a+1)(2a+4)(2a+3)(2a+1)} \right]^{\frac{1}{2}} (a-2\alpha) \\
 \left( \begin{array}{ccc} a & a+1 & 2 \\ \alpha & -\alpha & 0 \end{array} \right) = (-)^{a-\alpha-1} \alpha \left[ \frac{3(a+\alpha+1)(a-\alpha+1)}{a(a+1)(a+2)(2a+3)(2a+1)} \right]^{\frac{1}{2}} \\
 \left( \begin{array}{ccc} a & a+2 & 2 \\ \alpha & -\alpha-2 & 2 \end{array} \right) = (-)^{a-\alpha} \left[ \frac{(a+\alpha+1)(a+\alpha+2)(a+\alpha+3)(a+\alpha+4)}{(2a+5)(2a+4)(2a+3)(2a+2)(2a+1)} \right]^{\frac{1}{2}} \\
 \left( \begin{array}{ccc} a & a+2 & 2 \\ \alpha & -\alpha-1 & 1 \end{array} \right) = (-)^{a-\alpha-1} \left[ \frac{(a+\alpha+1)(a+\alpha+2)(a+\alpha+3)(a-\alpha+1)}{(a+1)(a+2)(2a+1)(2a+3)(2a+5)} \right]^{\frac{1}{2}} \\
 \left( \begin{array}{ccc} a & a+2 & 2 \\ \alpha & -\alpha & 0 \end{array} \right) = (-)^{a-\alpha} \left[ \frac{3(a+\alpha+1)(a+\alpha+2)(a-\alpha+1)(a-\alpha+2)}{(a+1)(2a+5)(2a+4)(2a+3)(2a+1)} \right]^{\frac{1}{2}}
 \end{array}$$

$$\langle ab\alpha\beta | c-\gamma \rangle = (-1)^{a-b-\gamma} \sqrt{2c+1} \begin{pmatrix} a & b & c \\ \alpha & \beta & \gamma \end{pmatrix}$$